

TRS7 Series SPD

SPD type 2–surge arrester, MOV
Pluggable module, visual fault signalling

- Varistor surge arrester
- Installation to sub–distribution boards (I_{max}:80kA) or main distribution boards (I_{max}:100kA/120kA/150kA)
- For protection of installations and equipments against impact of induced overvoltage during a lightning strike or switching overvoltages.
- Optional remote fault signalling(s)

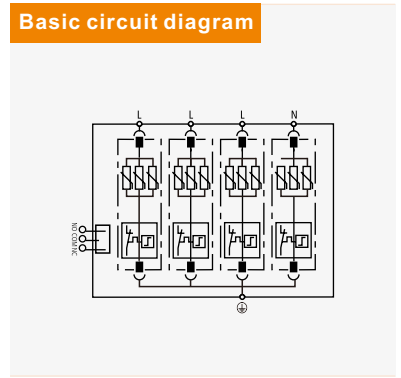
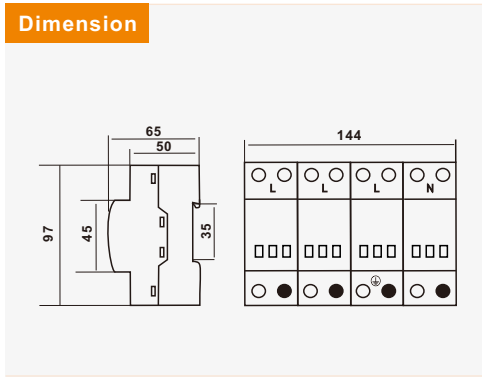
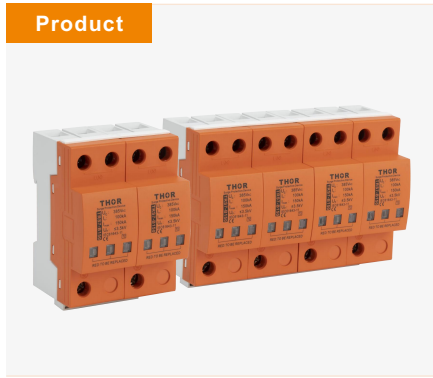

T2 AC SPD

Parameter/Type		TRS7–B80	TRS7–B100	TRS7–B120	TRS7–B150
Nominal voltage	U_n	380V AC			
Maximum operating voltage	U_c	385V AC			
Nominal discharge current (8/20 μ s)	I_n	40kA	60kA	80kA	100kA
Maximum discharge current (8/20 μ s)	I_{max}	80kA	100kA	120kA	150kA
Voltage protection level	U_p	$\leq 2,4kV$	$\leq 2,5kV$	$\leq 3,0kV$	$\leq 3,5kV$
Response time	t_a	< 25ns			
Cross–section of connected conductors solid(min/max)		16mm ² /35mm ²			
Cross–section of connected conductors stranded(min/max)		16mm ² /35mm ²			
Fault indication		red indication field			
Remote indication		potential–free change–over contact			
remote indication contacts		250V/0,5A AC, 250V/0,1A DC			
Cross–section of remote indication conductors		1,5mm ²			
Degree of protection		IP20			
Range of operating temperatures (min/ max)		–40°C~ +70°C			
Humidity range		5%~95%			
Mounting		DIN rail 35 mm			
According to standard		EN 61643–11:2012, IEC 61643–11:2011/T2			
Remarks		Other U_c can be customized. (420VAC, 385VAC, 320VAC, etc.)			

AC SPD Wiring diagram

Single phase system

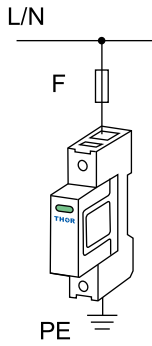

"1+0"
Connection

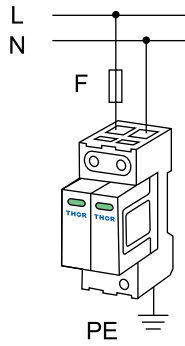

"2+0"
Connection

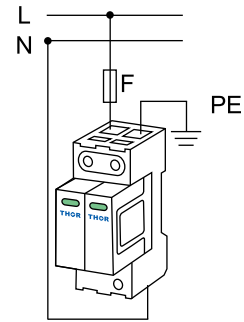

"1+1"
Connection

Three phase system

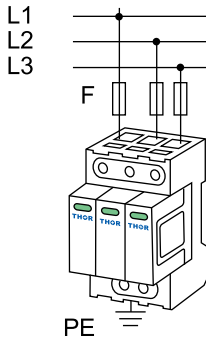

"3+0"
Connection

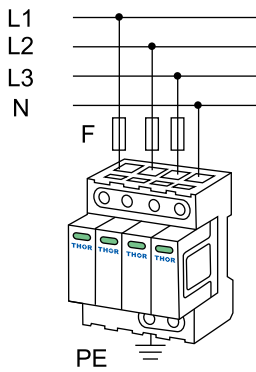

"4+0"
Connection

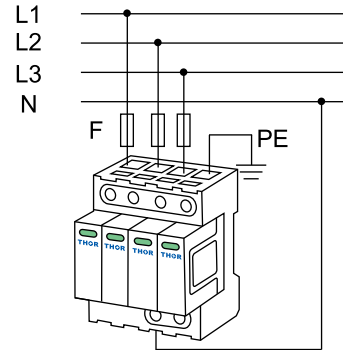

"3+1"
Connection

Connection of AC SPD in networks

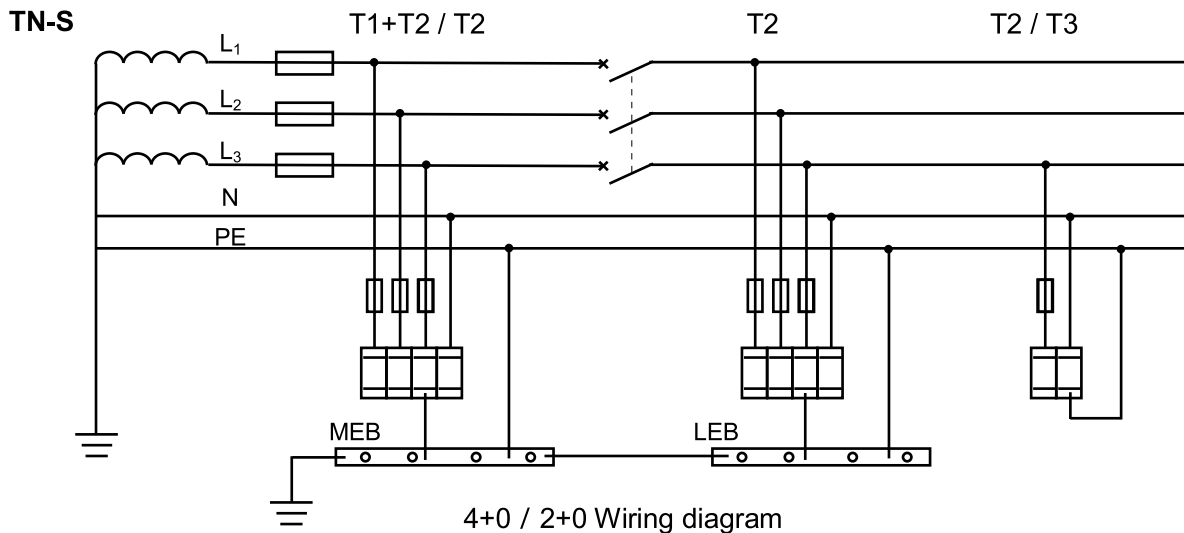

Connection of AC SPD in networks

